

DVI Parrot

Featuring
Parrot Trainer software



The EDID Emulator by

CARALLON

- Unique new accessory for the video professional. Allows user-configurable EDID management.
- Precise analysis and/or control of all EDID parameters via USB. "Trainer" software included – Mac or Windows.
- Standard EDID library supplied or the user can capture and edit, or create their own EDID profiles from scratch.
- Profiles can be permanently saved as computer files which can be copied, emailed, archived, etc.
- Libraries can be imported and exported to share and manage EDID settings.
- Trainer software supports multiple Parrots for devices with multiple outputs.
- Accessible Mode button and RGB Status LED provide basic hardware control.
- Dual-link DVI-I compatible for both high bandwidth digital and analog functionality.
- DVI powered for spoofing & capture, USB powered for "training" – no additional PSU required.
- Compatible with VESA EDID 1.3 and EDID Extensions EIA/CEA-861 (HDTV support etc.).
- Rugged, compact device – only 1.1 inch cable insertion / panel depth.
- Elegant and cost-effective solution for the real-world challenges faced by today's video technicians.

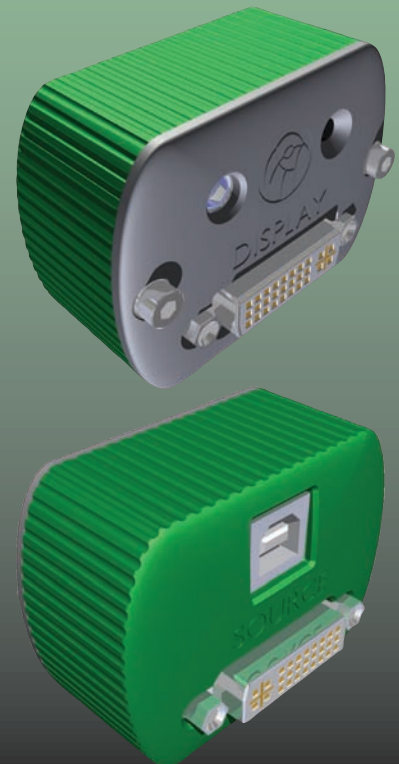
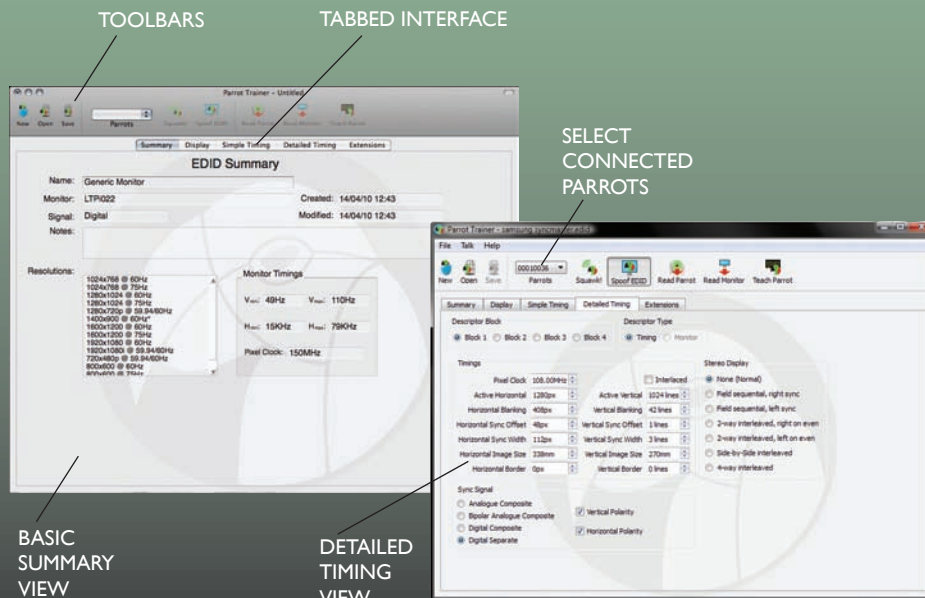

Exclusively Distributed by TMB



LOS ANGELES

10643 Glenoaks Blvd.
Pacoima, CA 91331
USA

Tel: +1 818.899.8818
Fax: +1 818.899.8813

LONDON

21 Armstrong Way
Southall
UB2 4SD England

Tel: +44 (0)20.8574.9700
Fax: +44 (0)20.8574.9701

NEW YORK

100 Asia Place
Carlstadt, NJ 07022
USA

Tel: +1 201.896.8600
Fax: +1 201.896.8601

BEIJING

No. 309, Building 6
Sanlitun Nanlu
Chaoyang District
Beijing, China 100027

Tel: +86 10.8492.1587
Fax: +86 10.8492.7635

TORONTO

409 Saddle St. West
Box 654, Durham
Ontario N0G-1R0

Tel: +1 519.369.9990
Fax: +1 519.369.9992

DVI Parrot

Dimensions in
Inches [mm]

USB CONFIGURATION

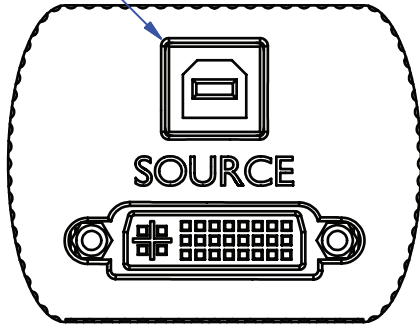

1.342 [34.1]

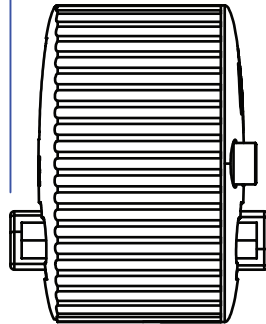

RGB STATUS LED

MODE SWITCH

2.150 [54.6]

1.650 [41.9]

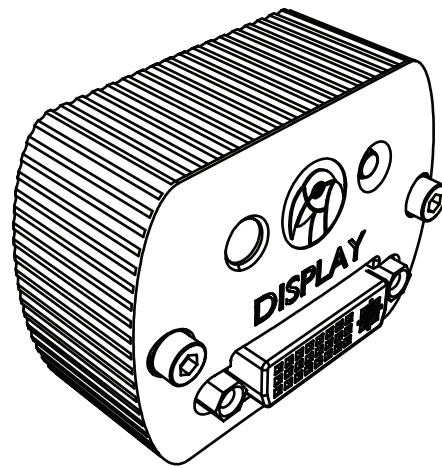
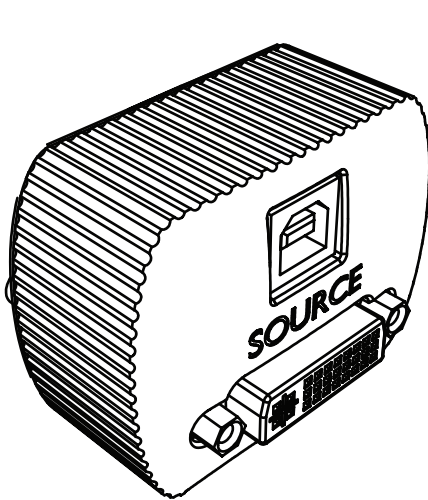
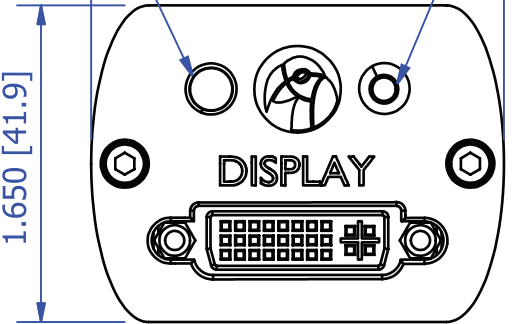

1.096 [27.8]
CABLE INSERTION
/ PANEL DEPTH

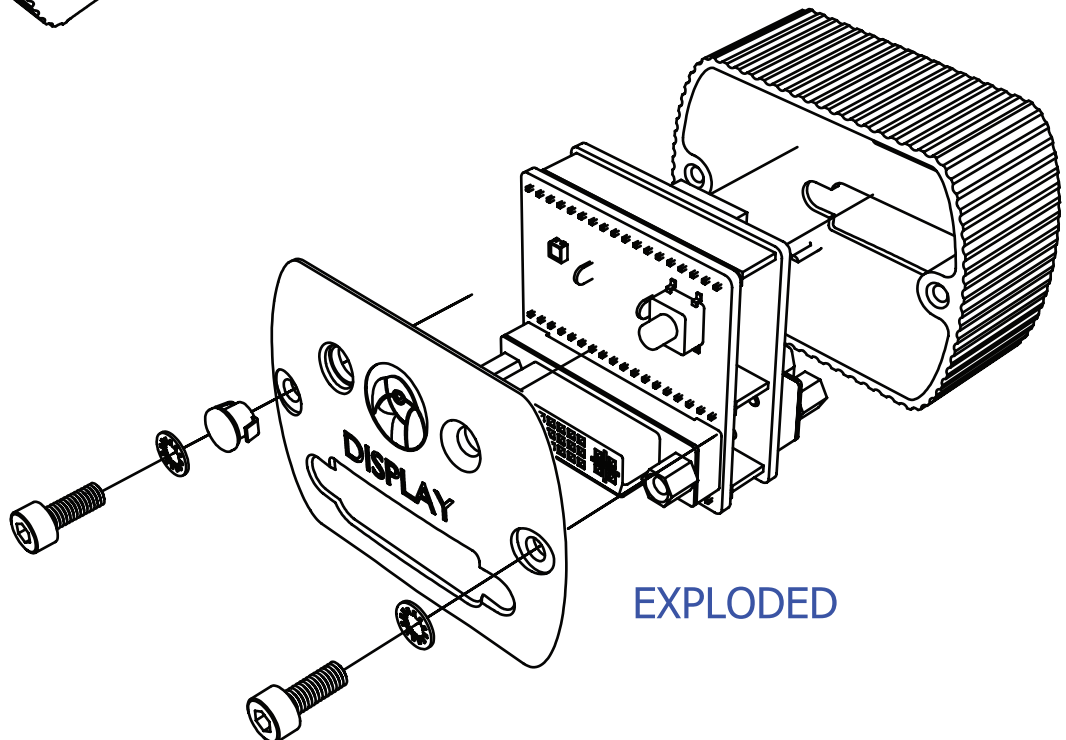
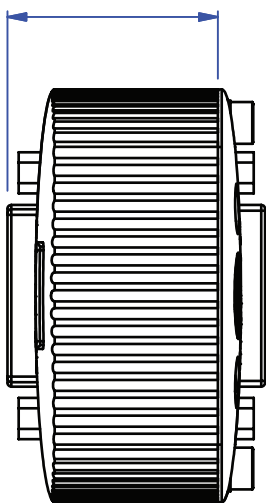

EXPLODED